

Solar Battery SX12-75 12V 75Ah



SX series designed for true-deep cycle solar applications, with features like thick, pure virgin lead plates (99.996%), heavy-duty over-the-partition welds, super-C additive and a proprietary gel formulation designed for years of cycling long service life. SX is well-suited to all deep-cycle off-grid solar power system, from commercial to personal, solar sites.

SX can provide the best and reliable service under extreme conditions such as high temperature and frequent power outages for Solar project.

SX is the highly reliable, safe, and maintenance-free option.

Long Life

GEL Technology

Deep Cycle



General Features

- Able to operate at 40-60°C
- DOD 50% 1500 times Cycles
- Integrated design to ensure the best Uniformity and reliability
- Long life and high stability under high temp. environment (no air-con needed)
- Use super-C additives: Deep discharge recovery capability

Dimensions & Weight

Length (mm)	260±1
Width (mm)	169±1
Height (mm)	211±1
Total Height (mm)	215±1
Weight (kg)	25.3±3%

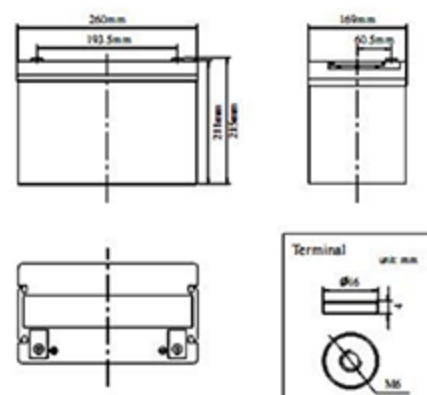

Technical Specifications

Nominal Voltage		12V (6 cells per unit)
Design Floating Life @25°C		15 Years
Nominal Capacity @25°C(20 hour rate@3.75A,10.8V)		75Ah
Capacity @25°C	10hour rate (6.8A,10.8V)	68Ah
	5 hour rate (11.9A,10.5V)	59.5Ah
	1 hour rate (45.8A,9.6V)	45.8Ah
Internal Resistance	Full Charged Battery@25°C	≤6.5mΩ
Ambient Temperature	Discharge	-25°C~60°C
	Charge	-25°C~60°C
	Storage	-25°C~60°C
Max.Discharge Current@25°C		450A(5s)
Capacity affected by Temperature (10 hour rate)	40°C	108%
	25°C	100%
	0°C	90%
	-15°C	70%
Self-Discharge@25°C per Month		3%
Charge (Constant Voltage) @25°C	Standby Use	Initial Charging Current Less than 17A Voltage 13.6-13.8V
	Cycle Use	Initial Charging Current Less than 17A Voltage 14.4-14.9V

Battery Discharge Table

Discharge Constant Current per Cell (Amperes at 25° C)

F.V/Time	15min	30min	45min	1h	2h	3h	5h	8h	10h	20h	100h
1.60V	121.3	73.8	49.5	45.8	26.4	18.6	12.6	8.3	7.4	4.05	0.90
1.65V	119.1	72.5	48.6	45.0	26.0	18.2	12.4	8.2	7.3	3.98	0.88
1.70V	116.9	71.2	47.7	44.1	25.5	17.9	12.2	8.0	7.2	3.90	0.87
1.75V	114.7	69.8	46.8	43.3	25.0	17.6	11.9	7.9	7.0	3.83	0.85
1.80V	110.3	67.1	45.0	41.6	24.0	16.9	11.5	7.6	6.8	3.75	0.83

Discharge Constant Power per Cell (Watts at 25°C)

F.V/Time	15min	30min	45min	1h	2h	3h	5h	8h	10h	20h	100h
1.60V	233.5	142.1	95.3	88.1	50.9	35.7	24.3	16.0	14.3	7.8	1.73
1.65V	229.2	139.6	93.6	86.5	50.0	35.1	23.9	15.7	14.0	7.7	1.70
1.70V	225.0	137.0	91.8	84.9	49.0	34.4	23.4	15.5	13.8	7.5	1.67
1.75V	220.7	134.4	90.1	83.3	48.1	33.8	23.0	15.2	13.5	7.4	1.63
1.80V	212.2	129.2	86.6	80.1	46.3	32.5	22.1	14.6	13.0	7.2	1.60

Note: The above data are average values, and can be obtained within 3 charge/discharge cycles. These are not minimum values. Cell and battery designs/specifications are subject to modification without notice. Contact CSBattery for the latest information.

Durable Battery Choose CSBattery

Copyright© 2016 CSBattery Energy Co., Limited

Solar Battery SX12-75 12V 75Ah



Performance Characteristics

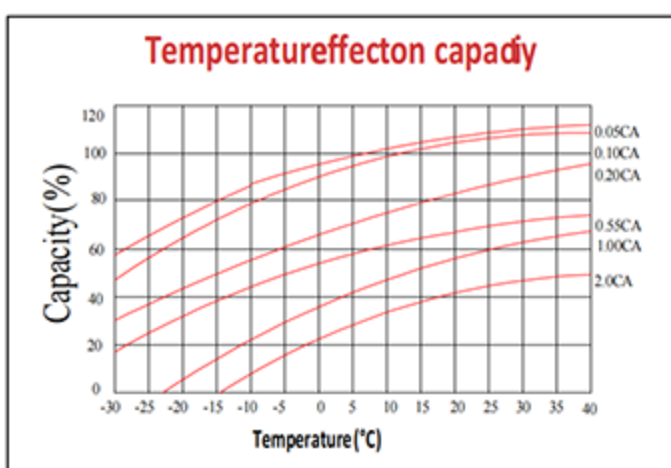
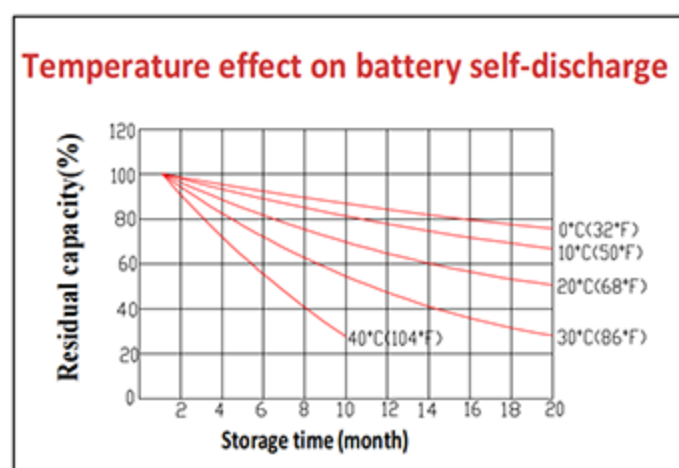
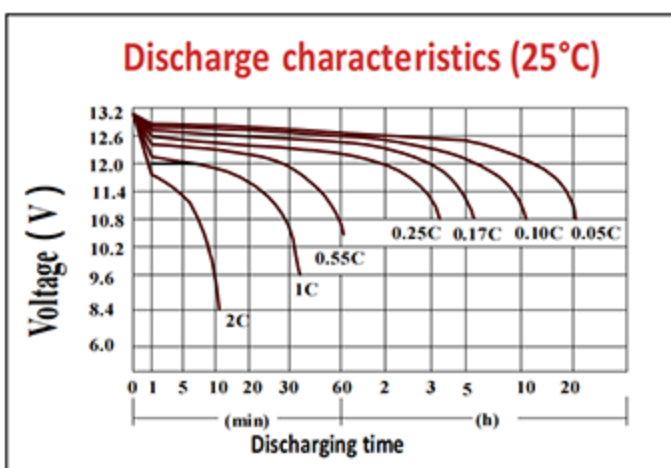
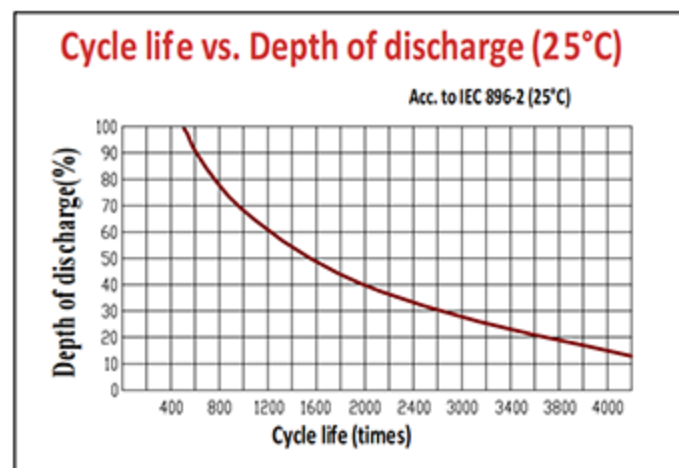
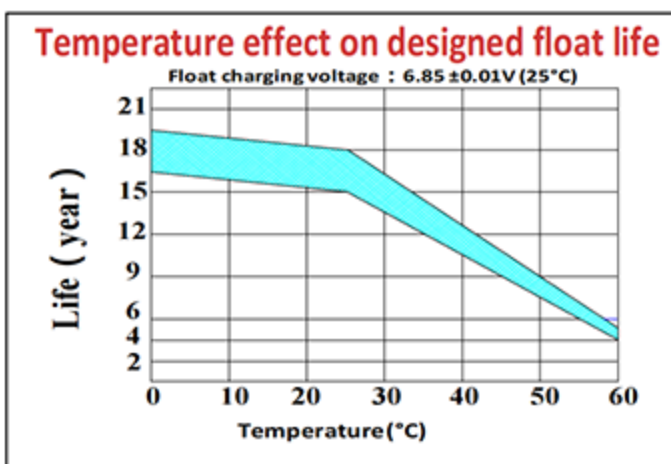
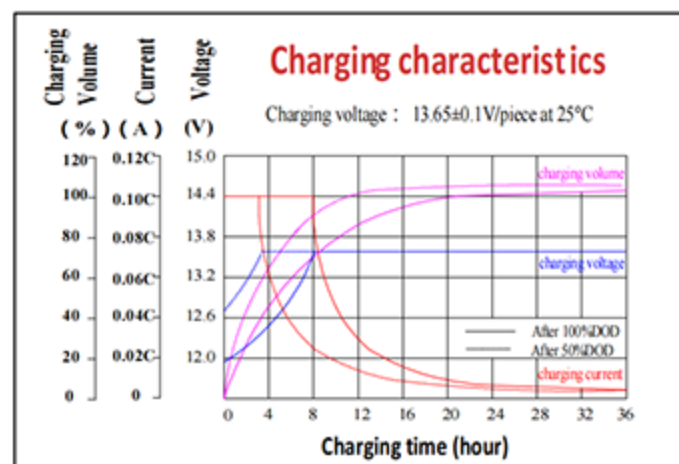

Battery Construction

Component	Positive plate	Negative plate	Container & Cover	Safety valve
Features	Thick high Sn low Ca grid with Special paste	Balanced Pb-Ca grid for improved recombination efficiency	Fire resistant e ABS (UL94-V0optional)	Flame Si-Rubber and aging resistance
Component	Terminal	Separator	Electrolyte	Pillar seal
Features	Female Copper Insert	Advanced PVC /AGM separator for high pressure cell design	German Evonik Silicon GEL	Two layers epoxy resin seal

Add: Building Evolution, Xingdong industry Park, NO.61, Liuxian 2nd Road, Baoan, Shenzhen, China.
Tel: +86-755-29123661 Email: Sales@CSBattery.cn, Support@CSBattery.cn
Website: www.CSBattery.cn

Durable Battery Choose CSBattery

Copyright© 2016 CSBattery Energy Co., Limited