

Solar Battery SX12-85 12V 85Ah



SX series designed for true-deep cycle solar applications, with features like thick, pure virgin lead plates (99.996%), heavy-duty over-the-partition welds, super-C additive and a proprietary gel formulation designed for years of cycling long service life. SX is well-suited to all deep-cycle off-grid solar power system, from commercial to personal, solar sites.

SX can provide the best and reliable service under extreme conditions such as high temperature and frequent power outages for Solar project.

SX is the highly reliable, safe, and maintenance-free option.

Long Life

GEL Technology

Deep Cycle



COMPLIED STANDARDS
 IEC 60896-21/22 JIS C8704
 IEC61427 BS6290 part4
 GB/T 19638 CE/ISO



General Features

- Able to operate at 40-60°C
- DOD 50% 1500 times Cycles
- Integrated design to ensure the best Uniformity and reliability
- Long life and high stability under high temp. environment (no air-con needed)
- Use super-C additives: Deep discharge recovery capability

Dimensions & Weight

| | |
|-------------------|---------|
| Length (mm) | 260±1 |
| Width (mm) | 169±1 |
| Height (mm) | 211±1 |
| Total Height (mm) | 215±1 |
| Weight (kg) | 26.2±3% |

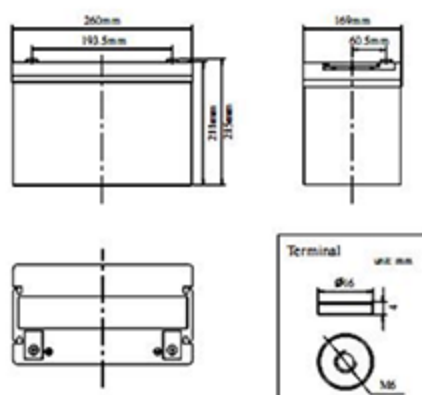

Technical Specifications

| | | |
|--|---------------------------|--|
| Nominal Voltage | | 12V (6 cells per unit) |
| Design Floating Life @25°C | | 15 Years |
| Nominal Capacity @25°C(20 hour rate@4.25A,10.8V) | | 85Ah |
| Capacity @25°C | 10hour rate (7.7A,10.8V) | 77Ah |
| | 5 hour rate (13.5A,10.5V) | 67.5Ah |
| | 1 hour rate (51.9A,9.6V) | 51.9Ah |
| Internal Resistance | Full Charged Battery@25°C | ≤6.0mΩ |
| Ambient Temperature | Discharge | -25°C~60°C |
| | Charge | -25°C~60°C |
| | Storage | -25°C~60°C |
| Max.Discharge Current@25°C | | 510A(5s) |
| Capacity affected by Temperature (10 hour rate) | 40°C | 108% |
| | 25°C | 100% |
| | 0°C | 90% |
| | -15°C | 70% |
| Self-Discharge@25°C per Month | | 3% |
| Charge (Constant Voltage) @25°C | Standby Use | Initial Charging Current Less than 19A Voltage 13.6-13.8V |
| | Cycle Use | Initial Charging Current Less than 19A Voltage 14.4-14.9V |

Battery Discharge Table

Discharge Constant Current per Cell (Amperes at 25° C)

| F.V/Time | 15min | 30min | 45min | 1h | 2h | 3h | 5h | 8h | 10h | 20h | 100h |
|----------|-------|-------|-------|------|------|------|------|-----|-----|------|------|
| 1.60V | 137.4 | 83.7 | 56.1 | 51.9 | 30.0 | 21.0 | 14.3 | 9.4 | 8.4 | 4.59 | 1.02 |
| 1.65V | 134.9 | 82.2 | 55.1 | 50.9 | 29.4 | 20.7 | 14.0 | 9.3 | 8.3 | 4.51 | 1.00 |
| 1.70V | 132.4 | 80.6 | 54.1 | 50.0 | 28.9 | 20.3 | 13.8 | 9.1 | 8.1 | 4.42 | 0.98 |
| 1.75V | 129.9 | 79.1 | 53.0 | 49.1 | 28.3 | 19.9 | 13.5 | 8.9 | 8.0 | 4.34 | 0.96 |
| 1.80V | 125.0 | 76.1 | 51.0 | 47.2 | 27.2 | 19.1 | 13.0 | 8.6 | 7.7 | 4.25 | 0.94 |

Discharge Constant Power per Cell (Watts at 25°C)

| F.V/Time | 15min | 30min | 45min | 1h | 2h | 3h | 5h | 8h | 10h | 20h | 100h |
|----------|-------|-------|-------|------|------|------|------|------|------|-----|------|
| 1.60V | 264.6 | 161.1 | 108.0 | 99.9 | 57.7 | 40.5 | 27.5 | 18.2 | 16.2 | 8.8 | 1.96 |
| 1.65V | 259.8 | 158.2 | 106.0 | 98.1 | 56.6 | 39.8 | 27.0 | 17.8 | 15.9 | 8.7 | 1.93 |
| 1.70V | 255.0 | 155.2 | 104.1 | 96.3 | 55.6 | 39.0 | 26.5 | 17.5 | 15.6 | 8.5 | 1.89 |
| 1.75V | 250.1 | 152.3 | 102.1 | 94.4 | 54.5 | 38.3 | 26.0 | 17.2 | 15.3 | 8.3 | 1.85 |
| 1.80V | 240.5 | 146.4 | 98.2 | 90.8 | 52.4 | 36.8 | 25.0 | 16.5 | 14.7 | 8.2 | 1.82 |

Note: The above data are average values, and can be obtained within 3 charge/discharge cycles. These are not minimum values. Cell and battery designs/specifications are subject to modification without notice. Contact CSBattery for the latest information.

Durable Battery Choose CSBattery

Copyright© 2016 CSBattery Energy Co., Limited

Solar Battery SX12-85 12V 85Ah



Performance Characteristics

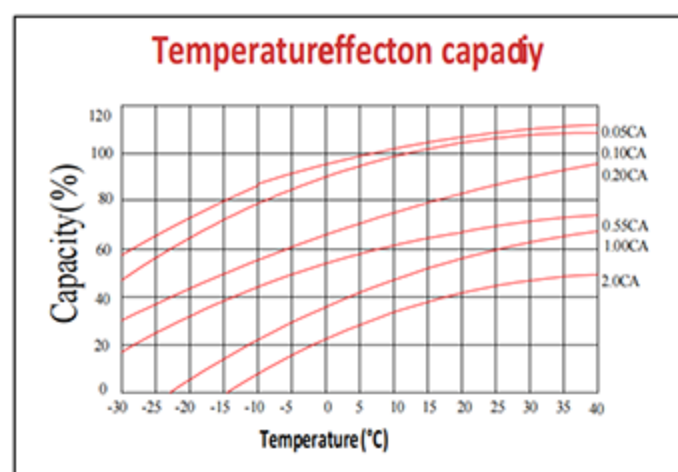
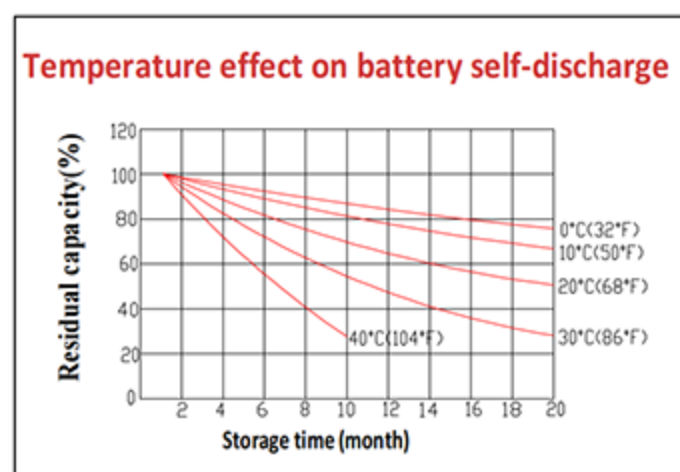
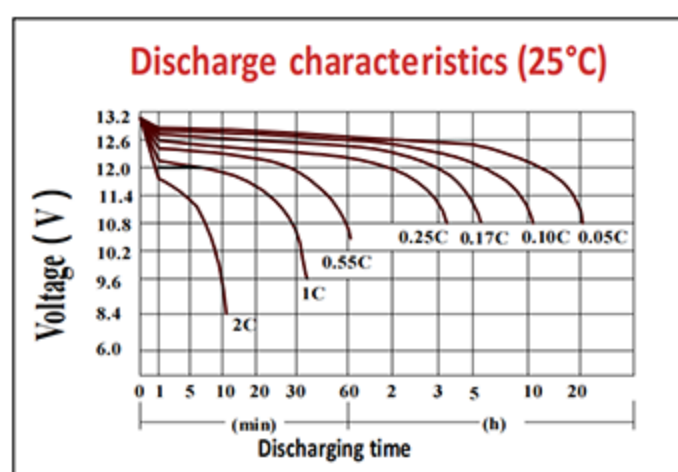
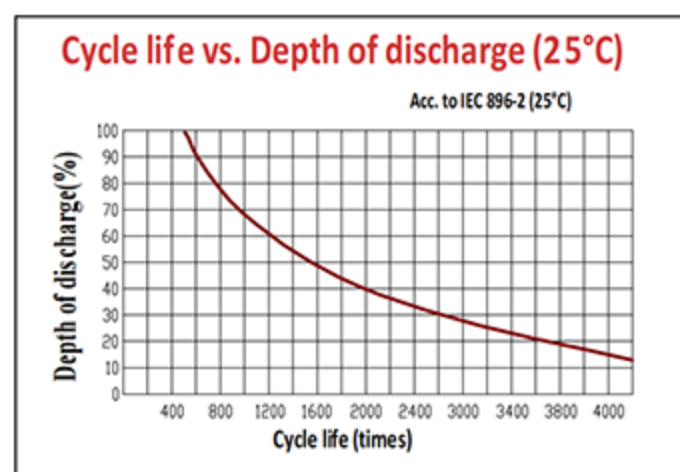
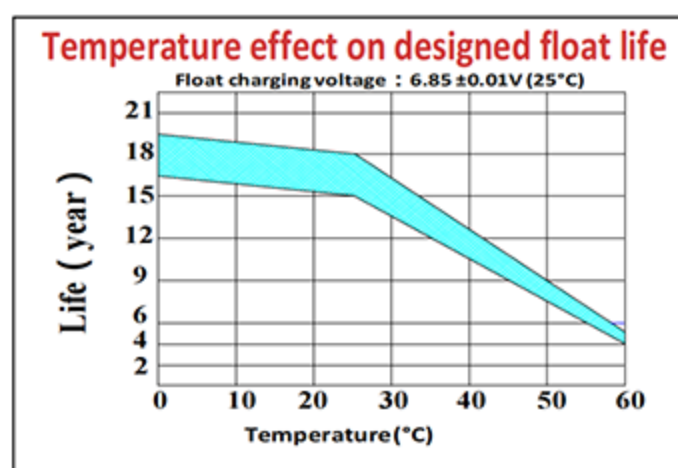
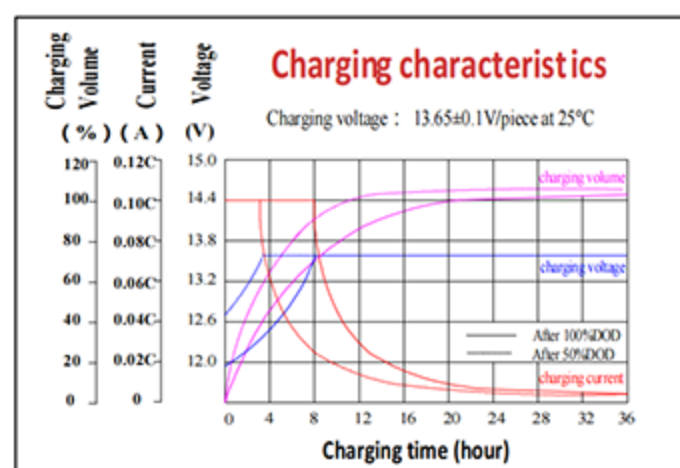

Battery Construction

| | | | | |
|-----------|--|---|--|--------------------------------------|
| Component | Positive plate | Negative plate | Container & Cover | Safety valve |
| Features | Thick high Sn low Ca grid with Special paste | Balanced Pb-Ca grid for improved recombination efficiency | Fire resistant e ABS (UL94-V0optional) | Flame Si-Rubber and aging resistance |
| Component | Terminal | Separator | Electrolyte | Pillar seal |
| Features | Female Copper Insert | Advanced PVC /AGM separator for high pressure cell design | German Evonik Silicon GEL | Two layers epoxy resin seal |

Add: Building Evolution, Xingdong industry Park, NO.61, Liuxian 2nd Road, Baoan, Shenzhen, China.
 Tel: +86-755-29123661 Email: Sales@CSBattery.cn, Support@CSBattery.cn
 Website: www.CSBattery.cn

Durable Battery Choose CSBattery

Copyright© 2016 CSBattery Energy Co., Limited